

Ventronic



Ballast Code	Type	Lamp Types
VTC320255	Dimming	320W (UNI-FORM, SON)

Electrical Data

Actual Lamp Power (W)	320	Power Factor	>0.95
Total Circuit Watts (W)	346	Lamp Waveform	Sine Wave
		Ignition Voltage (kV)	5
Input Voltage (V)	220 - 240 ± 10%	Short Circuit Protection	Yes
Frequency	50 / 60Hz	Continuous Open Circuit	Yes
Max Ballasts per Circuit	~	Maximum Cable Capacitance (pf)	3000
Output Power Adjustable	Yes	Nominal Current @ 240V	1.3
Maximum Dimming Power HPS	40	Maximum Current @ 185V	1.9
Maximum Dimming Power MH	50	Inrush Current (A)	25
THD (%)	<10	Lamp Operating Frequency (kHz)	>115

Physical Data / Requirements

Termination	Type	Leads
	Size	
	Length	200mm
Case Type	Aluminium Drawn	
Weight (g)	2200	
Length (mm)	219	
Width (mm)	120	
Height (mm)	91	
Fixings (mm)	233	
Thermal Protection	Yes	
End of Lamp Protection	Yes	
Maximum Case Temperature (°C)	90	
Thermal Protection Auto Reset	Yes	
Maximum Ambient Temperature (°C)	60	
Minimum Ambient Temperature (°C)	-40	

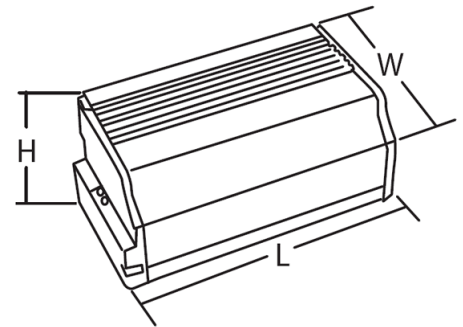

Status Indicator	Green - Normal	Yellow - Dimming	Red - Failure Warning
ON Constantly	Lamp is working normally	The lamp is working in the dimming mode	Ballast Malfunction
Quick flashing 2 times a second	Ballast is in the process of starting the lamp	The lamp is in the process of going over to the dimming mode	Lamp at end of life and cannot maintain normal power
Slow flashing every 2 seconds	Lamp is warming up	Waiting for lamp to cool	No lamp or lamp circuit disconnected

Additional Information